

Varenummer: 03445120  
Beskrivelse: Fluro Heavy Duty Ledleje GE 120 EW-2RS  
Hul Ø120  
Note: 120

## Mål

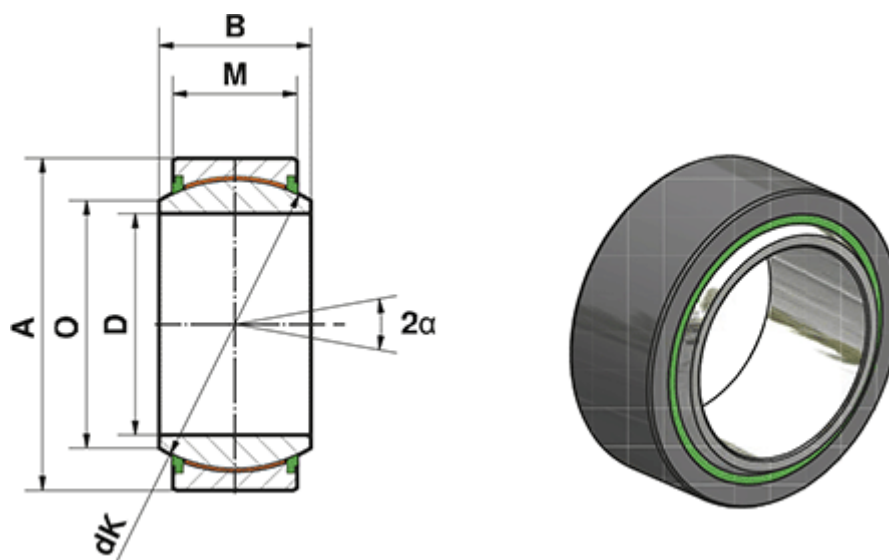

A	= 180
a (grader)	= 6
B	= 85
D	= 120
dK	= 160
Dynamisk belastning C (kN)	= 2685
M	= 70
O	= 135.5

Statisk belastning C0 (kN)	= 4475
Vægt (g)	= 8100